

STEP 1: Remove self-tapping screws from rear of Shur-Strap™.

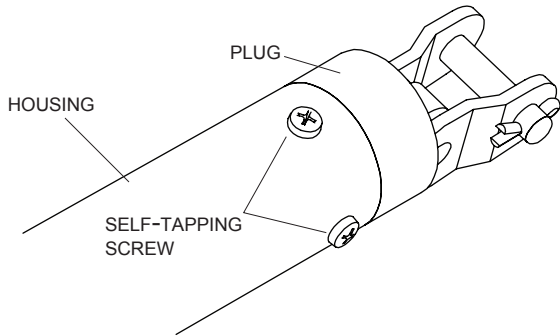

STEP 2: Remove spring assembly from housing.

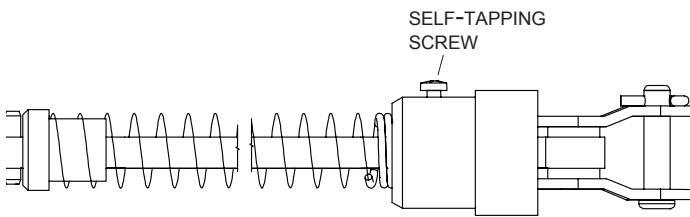

STEP 3: Remove spring pin from webbing loop at front of assembly.

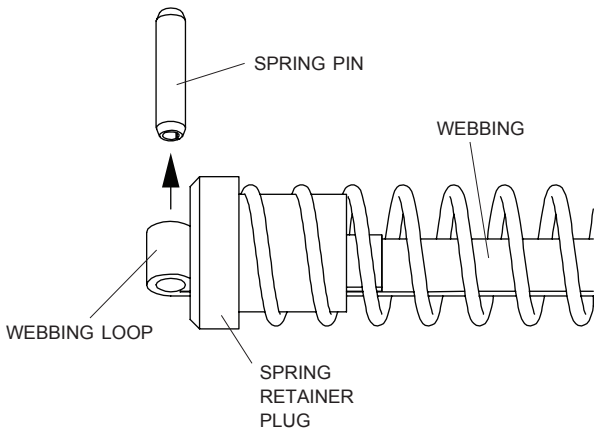

STEP 4: Pull webbing and connector link off spring.

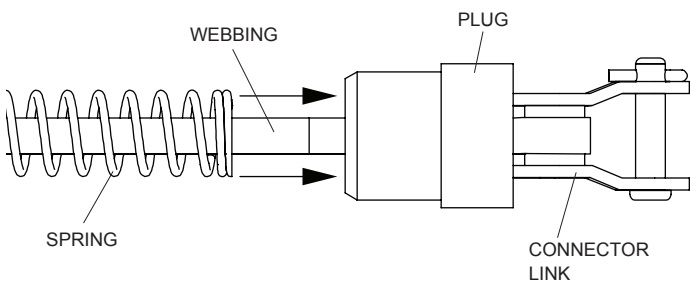

STEP 5: Remove plug from webbing and connector link.

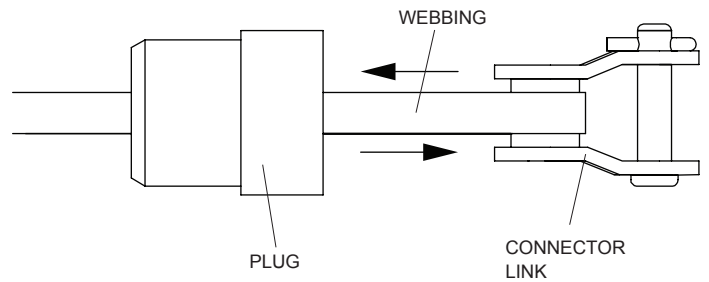

STEP 6: "Fish" new webbing through plug, spring and spring retainer plug.

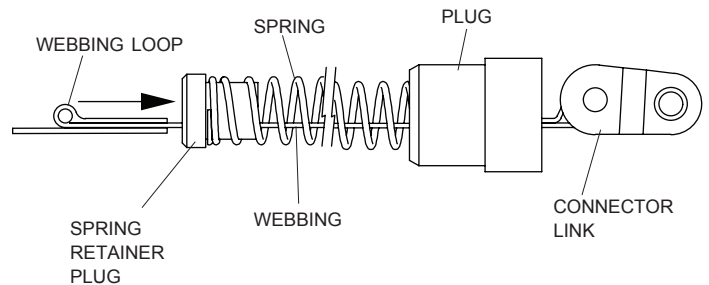

STEP 7: Insert spring pin through loop in webbing and cut off tail.

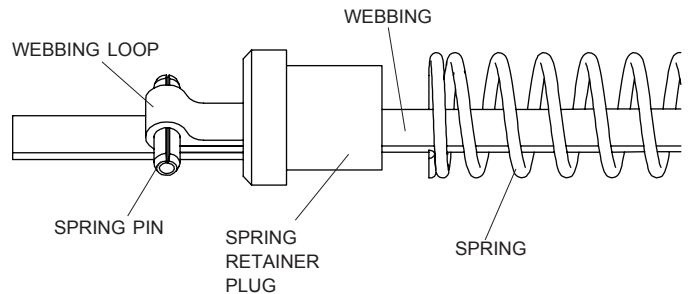

STEP 8: Re-install webbing and spring assembly into Shur-Strap™ housing. Secure with self-tapping screws.

